



Ref. 1701.2400009 230V  
Ref. 1701.2400010 400V

## Elevador de 2 Columnas Automático 4T con Base en H



Automatic | Automatique  
Automático | Automatico

- » Protectores para las puertas del vehículo.
- » Tacos de goma ajustables en 2 alturas.
- » Cables sincronizados.
- » Motor de aluminio.
- » Protector de la cadena.
- » Diseño engrasador con acceso fácil.
- » Certificación CE.

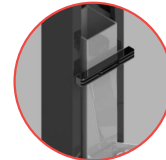

Protectores



Bloqueo brazo



Protector de cadena



Interruptor de límite



Válvula de seguridad

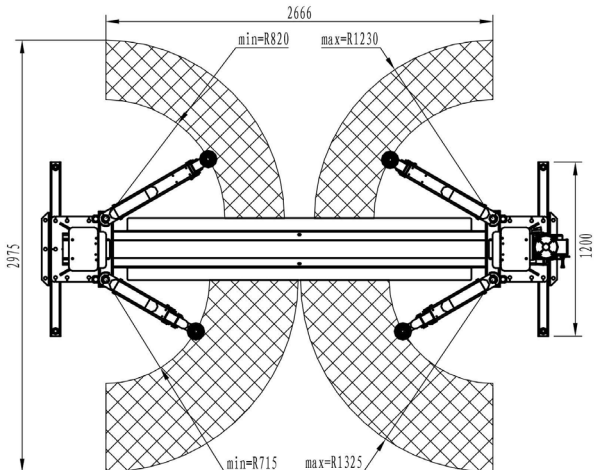
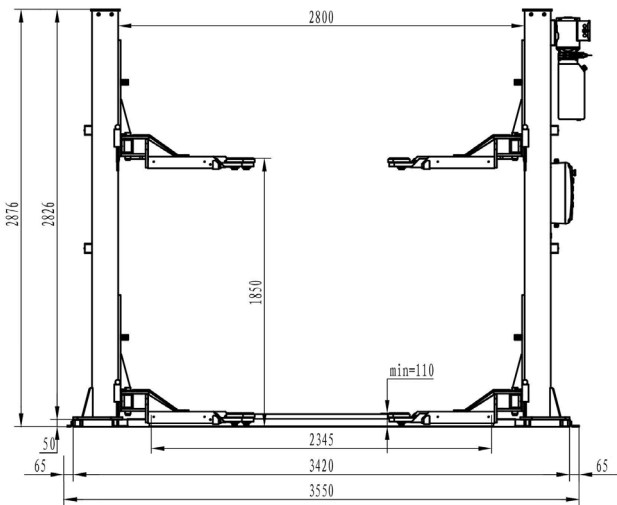

Capacidad máxima de carga	4T
Altura máxima de elevación	1850 mm
Altura mínima	110 mm
Altura total	2876 mm
Anchura total	3550 mm
Anchura entre columnas	2800 mm
Anchura útil entre columnas	2345 mm
Potencia del motor	2,2 kw
Alimentación	230V 50Hz 1PH (Ref. 1701.2400009) 400V 50Hz 3PH (Ref. 1701.2400010)
Grosor del acero	5 mm
Tiempo de elevación / bajada	≤ 45 s
Nº de brazos	2+3
Medida brazos (min-max)	2: 820/1230 mm 3: 715/1325 mm
Espesor mínimo de hormigón	200 mm
Peso neto	615 kg
Dimensiones bultos	2915*460*790 mm 870*270*310 mm 3300*460*65 mm (base H)















\*Ver recambios en las páginas 26 y 27.

	Referencia	Descripción	Para Elevador 2 columnas
	1799.1700012	<b>Taco de goma Ø115mm</b> Rubber pad Tampon en caoutchouc Almofada de borracha"	1701.2400009, 1701.2400010, 1701.2420001, 1701.2420002, 1701.2420003, 1701.2420004, 1701.2420005, 1701.2420006
	1799.1700008	<b>Protector goma para brazo 130*75*8mm</b> Arm rubber protector Protecteur caoutchouc bras Protetor de braço de borracha	1701.2400009, 1701.2400010, 1701.2420001, 1701.2420002, 1701.2420003, 1701.2420004, 1701.2420005, 1701.2420006
	1799.1700011	<b>Protector de columna</b> Column rubber pad Protecteur caoutchouc colonne Protetor de coluna	1701.2400009, 1701.2400010, 1701.2420001, 1701.2420002, 1701.2420003, 1701.2420004, 1701.2420005, 1701.2420006
	1799.1700024	<b>Realza 70mm</b> Extension pad Réhausseur Extensão	1701.2400009, 1701.2400010, 1701.2420001, 1701.2420002, 1701.2420003, 1701.2420004, 1701.2420005, 1701.2420006
	1799.1700013	<b>Realza 100mm</b> Extension pad Réhausseur Extensão	1701.2400009, 1701.2400010, 1701.2420001, 1701.2420002, 1701.2420003, 1701.2420004, 1701.2420005, 1701.2420006
	1799.1700006	<b>Juego juntas cilindro aceite</b> Oil cylinder seal kit Jeu joints cylindre d'huile Kit vedação cilindro de óleo	1701.2400009, 1701.2400010, 1701.2420001, 1701.2420002, 1701.2420003, 1701.2420004, 1701.2420005, 1701.2420006
	1799.1700010	<b>Guía deslizante - patín</b> Slider Glissière Control deslizante	1701.2400009, 1701.2400010, 1701.2420001, 1701.2420002, 1701.2420003, 1701.2420004, 1701.2420005, 1701.2420006
	1799.1700016	<b>Rodillo</b> Roller Rouleau Rolo	1701.2420005, 1701.2420006
	1799.1700002	<b>Elemento de válvula solenoide</b> Solenoid valve element Élément d'électrovanne Elemento da válvula solenóide	1701.2400009, 1701.2400010, 1701.2420003, 1701.2420004, 1701.2420005, 1701.2420006
	1799.1700003	<b>Bobina de válvula solenoide</b> Solenoid valve coil Bobine d'électrovanne Bobina da válvula solenóide	1701.2400009, 1701.2400010, 1701.2420003, 1701.2420004, 1701.2420005, 1701.2420006
	1799.1700005	<b>Válvula antirretorno</b> One-way valve Valve anti-retour Válvula anti-retorno	1701.2400009, 1701.2400010, 1701.2420001, 1701.2420002, 1701.2420003, 1701.2420004, 1701.2420005, 1701.2420006
	1799.1700017	<b>Válvula de sobrecarga</b> Overflow valve Valve protection surcharge Válvula de sobrecarga	1701.2420005, 1701.2420006
	1799.1700001	<b>Electroimán</b> Electromagnet Électro-aimant Eletróimã	1701.2400009, 1701.2400010, 1701.2420003, 1701.2420004, 1701.2420005, 1701.2420006
	1799.1700014	<b>Cable de acero 8,25m - x2uds</b> Steel rope Câble d'acier Corda de aço	1701.2420001, 1701.2420002, 1701.2420003, 1701.2420004

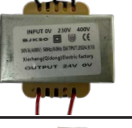
# RECAMBIOS PARA ELEVADORES 2 COLUMNAS

SPARE PARTS FOR 2 POST LIFTS | PIÈCES DE RECHANGE POUR PONTS ÉLÉVATEURS 2 COLONNES  
PEÇAS DE REPOSIÇÃO PARA 2 ELEVADORES DE COLUNA | PARTI DI RICAMBIO PER PONTI SOLLEVATORI A 2 COLONNE



	Referencia	Descripción	Para Elevador 2 columnas
	<b>1799.1700015</b>	<b>Cable de acero 10,44m - x2 uds</b> Steel rope Câble d'acier Corda de aço	1701.2420005, 1701.2420006
	<b>1799.1700047</b>	<b>Cable de acero 8,68m - x2 uds</b> Steel rope   Câble d'acier Corda de aço	1701.2400009, 1701.2400010
	<b>1799.1700004</b>	<b>Relé temporizado</b> Time relay   Relais temporisé Relé de tempo	1701.2420003, 1701.2420004, 1701.2420005, 1701.2420006, 1701.2400009, 1701.2400010
	<b>1799.1700007</b>	<b>Contactador AC</b> AC contactor Contacteur AC Contador AC	1701.2420001, 1701.2420002, 1701.2420003, 1701.2420004, 1701.2420005, 1701.2420006, 1701.2400009, 1701.2400010
	<b>1799.1700009</b>	<b>Interruptor límite</b> Limit switch Interrupteur limite Interruptor limite	1701.2420001, 1701.2420002, 1701.2420003, 1701.2420004, 1701.2420005, 1701.2420006, 1701.2400009, 1701.2400010
	<b>1799.1700152</b>	<b>Puente rectificador</b> Rectifier bridge   Pont redresseur Ponte retificadora	1701.2400009, 1701.2400010, 1701.2420003, 1701.2420004, 1701.2420005, 1701.2420006
	<b>1799.1700018</b>	<b>Interruptor de botón 1NO1NC</b> Button switch 1NO1NC Interrupteur bouton 1NO1NC Interruptor de botão 1NO1NC	1701.2420005, 1701.2420006
	<b>1799.1700019</b>	<b>Interruptor de botón 2NO</b> Button switch 2NO Interrupteur bouton 2NO Interruptor de botão 2NO	1701.2420005, 1701.2420006
	<b>1799.1700020</b>	<b>Transformador</b> Transformer Transformateur Transformador	1701.2420001, 1701.2420002
	<b>1799.1700048</b>	<b>Transformador</b> Transformer Transformateur Transformador	1701.2400009, 1701.2400010, 1701.2420003, 1701.2420004, 1701.2420005, 1701.2420006
	<b>1799.1700153</b>	<b>Disyuntor monofásico</b> Circuit breaker   Disjoncteur Disjuntor	1701.2420001, 1701.2420003, 1701.2400009, 1701.2420005
	<b>1799.1700021</b>	<b>Disyuntor</b> Circuit breaker   Disjoncteur Disjuntor	1701.2420005, 1701.2420006
	<b>1799.1700022</b>	<b>Disyuntor</b> Circuit breaker   Disjoncteur Disjuntor	1701.2420005, 1701.2420006
	<b>1799.1700023</b>	<b>Disyuntor</b> Circuit breaker 3 phases Disjoncteur 3PH   Disjuntor 3PH	1701.2420005, 1701.2420006